



M.W.Hartmann

Sterilization



39

39

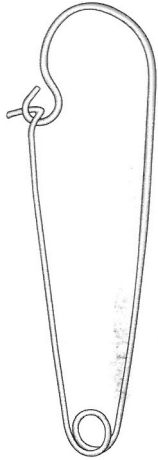

Bunt
MWH-39-200
 12 cm / 4¾"

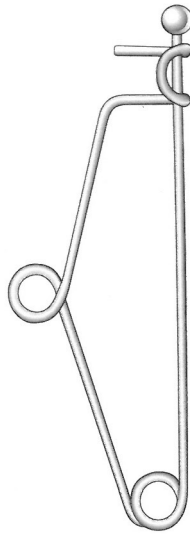

Mayo
MWH-39-202
 14 cm / 5½"

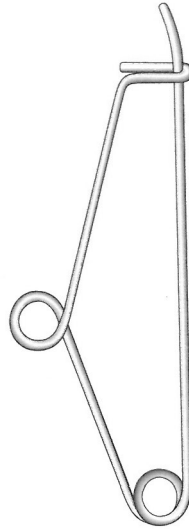

Mayo
MWH-39-204
 14 cm / 5½"

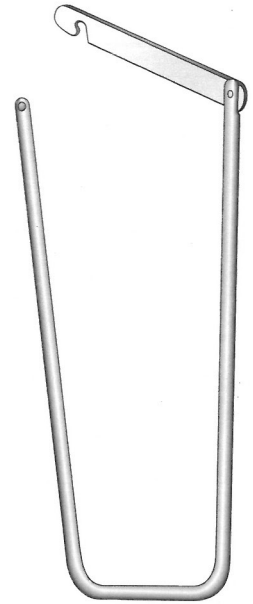

Surgeon
MWH-39-210 20 cm / 8"
MWH-39-212 25 cm / 10"
MWH-39-214 30 cm / 12"
MWH-39-216 40 cm / 16"
 With secure locking device

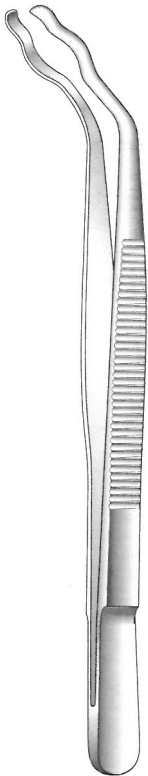

Davis
MWH-39-221 16 cm / 6¼"
MWH-39-222 20 cm / 8"
MWH-39-223 24 cm / 9½"

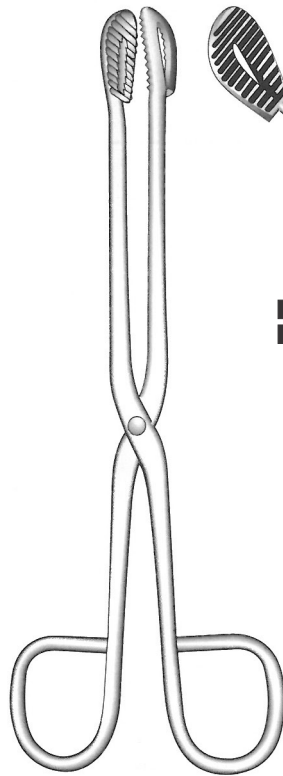

Universal
MWH-39-224 20 cm / 8"
MWH-39-225 28 cm / 11"
 Straight



MWH-39-226 20 cm / 8"
MWH-39-227 28 cm / 11"
 Angled

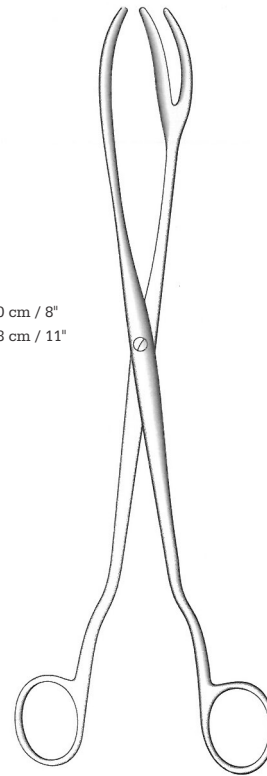

MWH-39-228 20 cm / 8"
MWH-39-229 30 cm / 12"

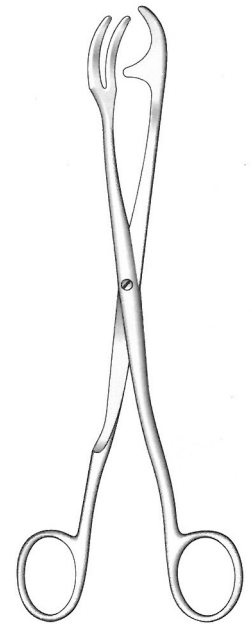

Rogge
MWH-39-230
 23 cm / 9"

Sterilization

Sterilizing Waste Forceps

Forcepskappenzangen

Combinacion tapa/pinza

M.W.Hartmann



MWH-39-236 25 cm / 10 "
MWH-39-260 32 cm / 12¾"
with ratchet

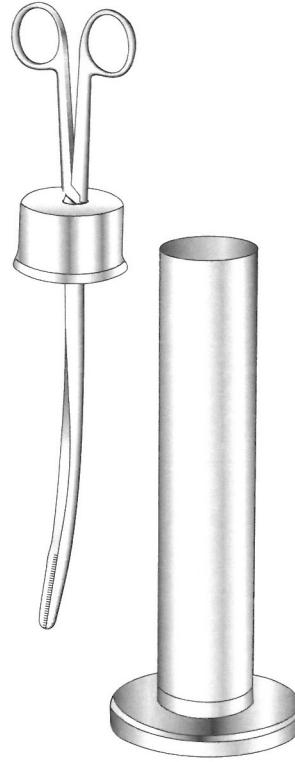

MWH-39-237 25 cm / 10 "
MWH-39-261 32 cm / 12¾"
without ratchet

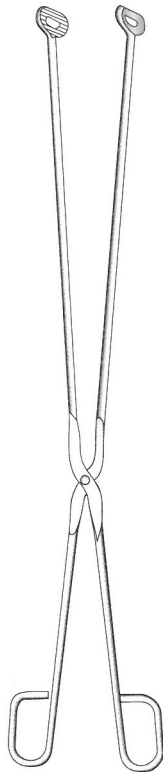

Modell
MWH-39-238
58 cm / 22¾"

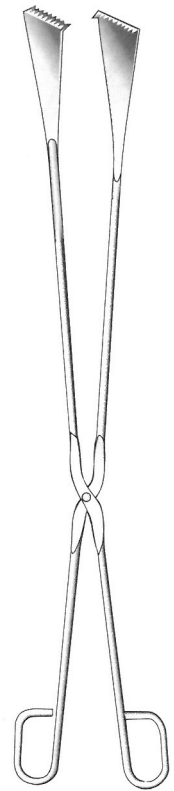

Sauerbruch
MWH-39-239
55 cm / 21½"

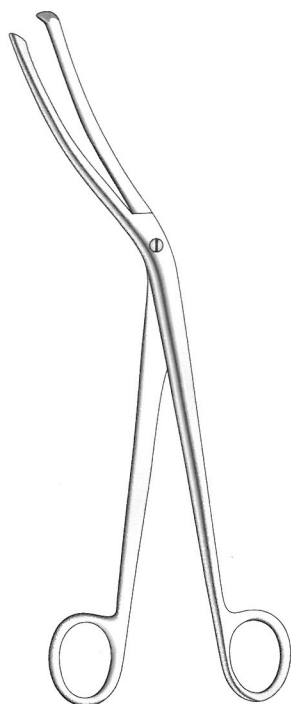

Cheatele
MWH-39-240
26.5 cm / 10½"

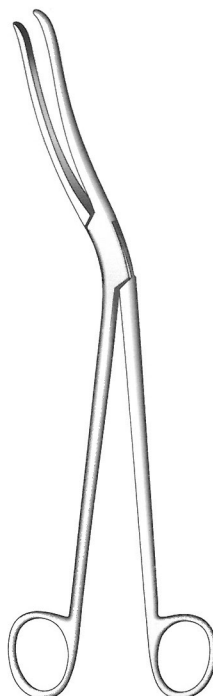

Cheatele
MWH-39-241
27 cm / 10½"

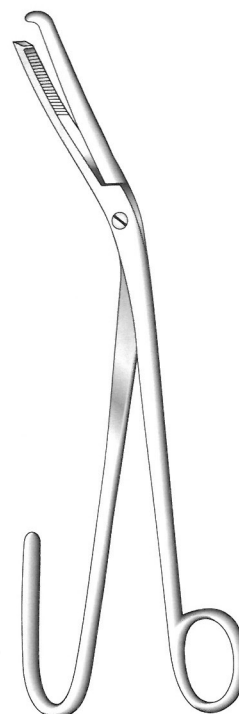

Cheatele
MWH-39-242
28 cm / 11"

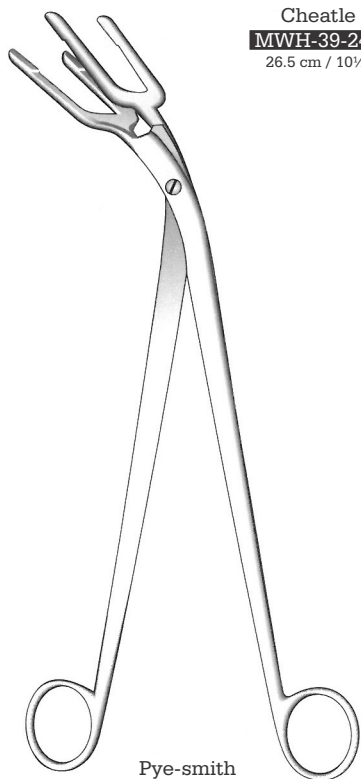

Pye-smith
Harrison
MWH-39-243 25 cm / 10"
MWH-39-244 30 cm / 12"

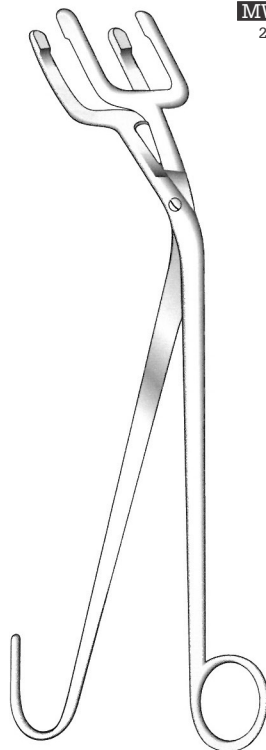

Harrison
MWH-39-245 25 cm / 10"
MWH-39-246 30cm / 12"
MWH-39-247 35 cm / 14"
MWH-39-248 45 cm / 18"

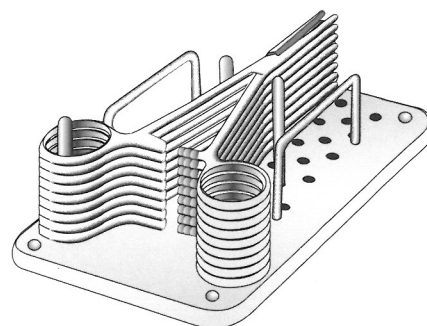

MWH-39-249