



Neurosurgery

*M.W.Hartmann*

*M.W.Hartmann*

Neurosurgery

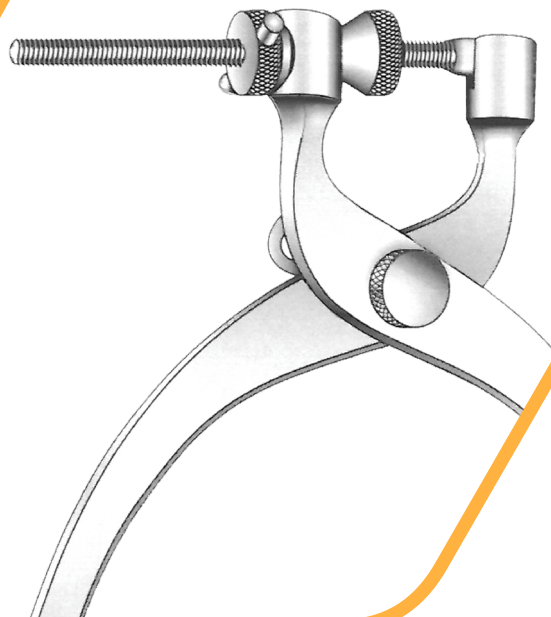

25

25

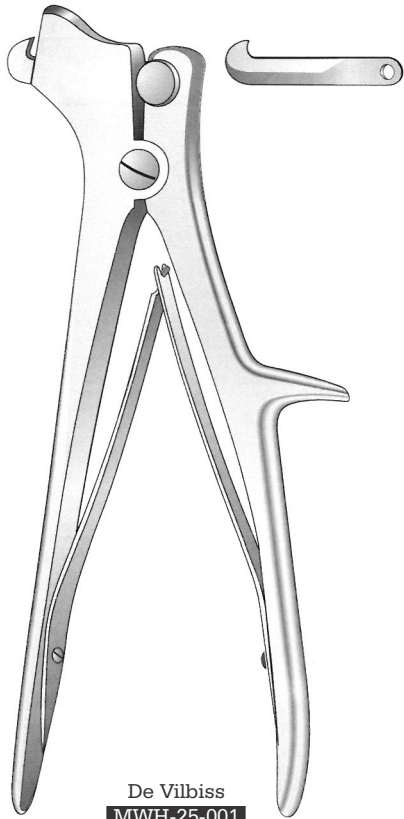

De Vilbiss  
**MWH-25-001**  
21 cm / 8¼"

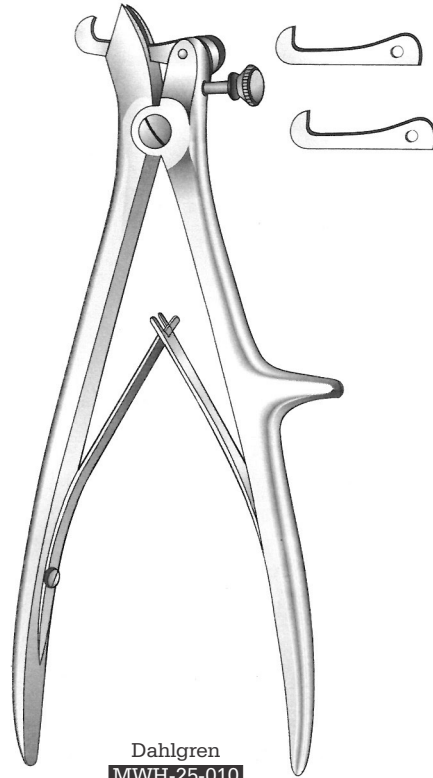

Dahlgren  
**MWH-25-010**  
20 cm / 8"



Cone  
**MWH-25-750**  
22.5 cm / 9"  
Cranial punch

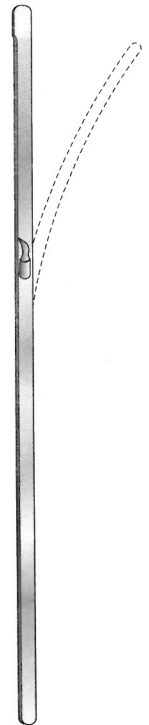

Martel  
**MWH-25-020**  
33 cm / 13"  
Saw guide, flexible

# Neurosurgery

Skull Traction Tongs  
Schadelhalter  
Estribos de traccion craneal

M.W.Hartmann

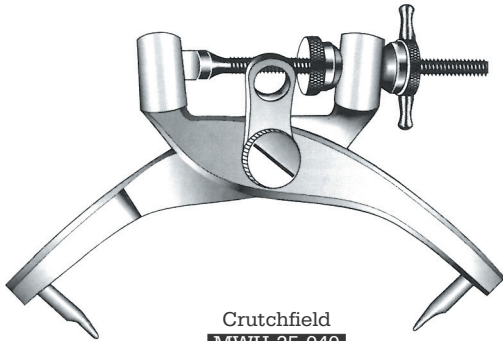

Crutchfield  
MWH-25-040  
Small pattern



Crutchfield  
MWH-25-050  
Medium pattern

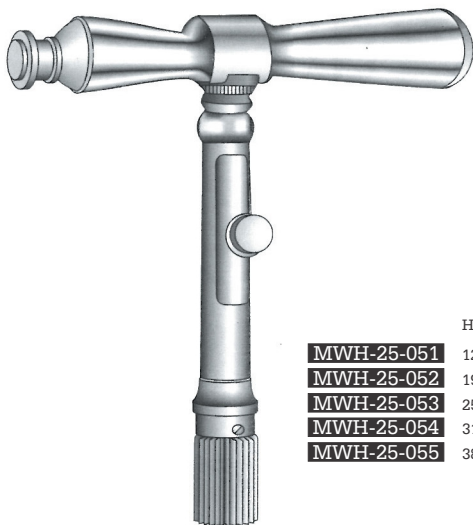

Hudson  
10 cm / 4"  
Trephine

	Hole size
MWH-25-051	12.7 mm / 1/2"
MWH-25-052	19 mm / 3/4"
MWH-25-053	25.4 mm / 1"
MWH-25-054	31.75 mm / 1 1/4"
MWH-25-055	38.1 mm / 1 1/2"

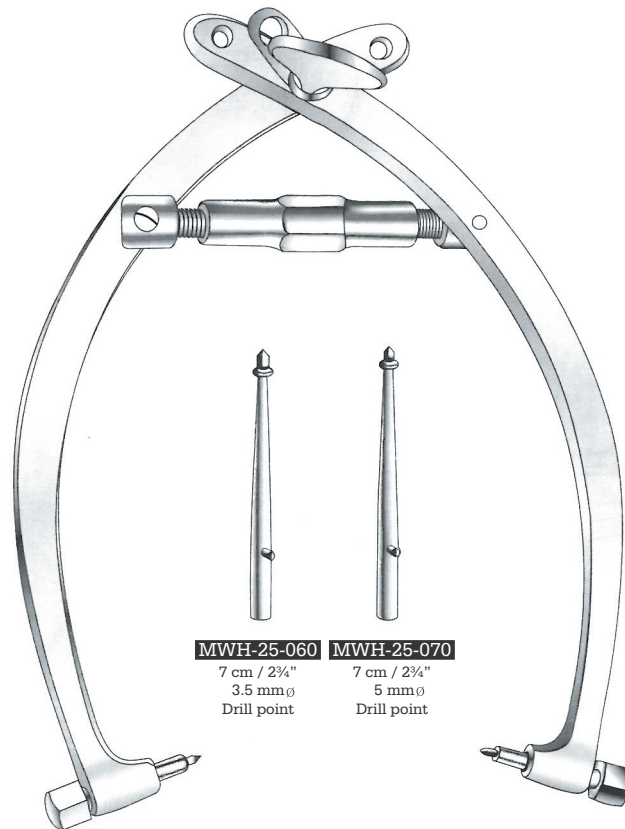

MWH-25-060	MWH-25-070
7 cm / 2 3/4"	7 cm / 2 3/4"
3.5 mm $\emptyset$	5 mm $\emptyset$
Drill point	Drill point

MWH-25-760 Small  
MWH-25-761 Large

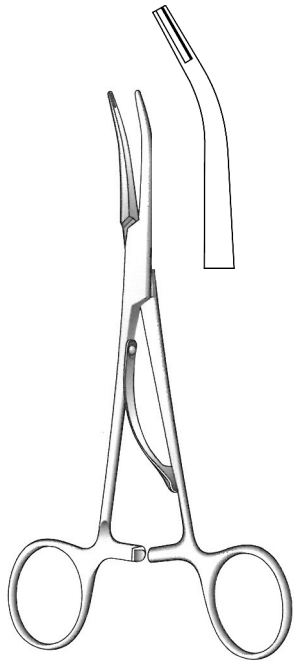

McKenzie  
**MWH-25-080** 15 cm / 6"  
**MWH-25-090** 19 cm / 7½"

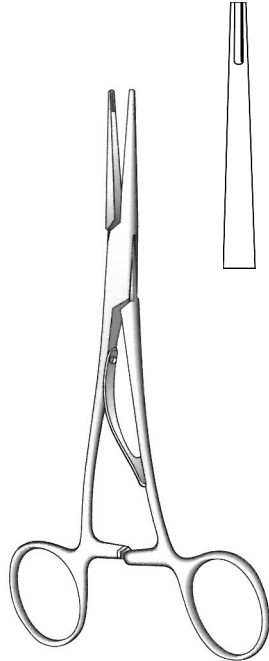

McKenzie  
**MWH-25-100** 15 cm / 6"  
**MWH-25-110** 19 cm / 7½"

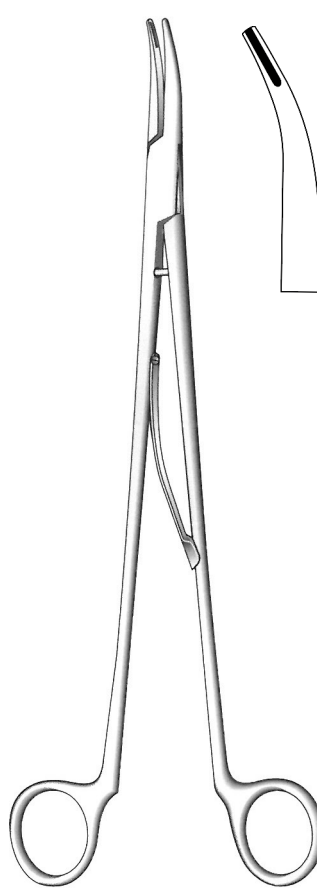

Smithwick  
**MWH-25-120** 23 cm / 9"  
**MWH-25-130** 26 cm / 10¼"

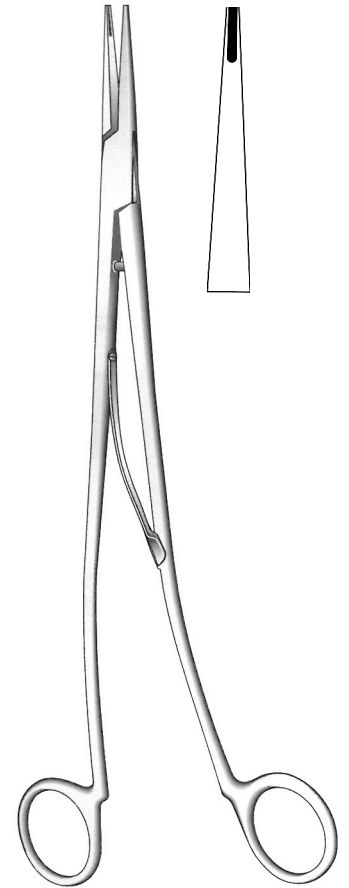

Sweet  
**MWH-25-140** 23 cm / 9"  
**MWH-25-150** 25 cm / 10"

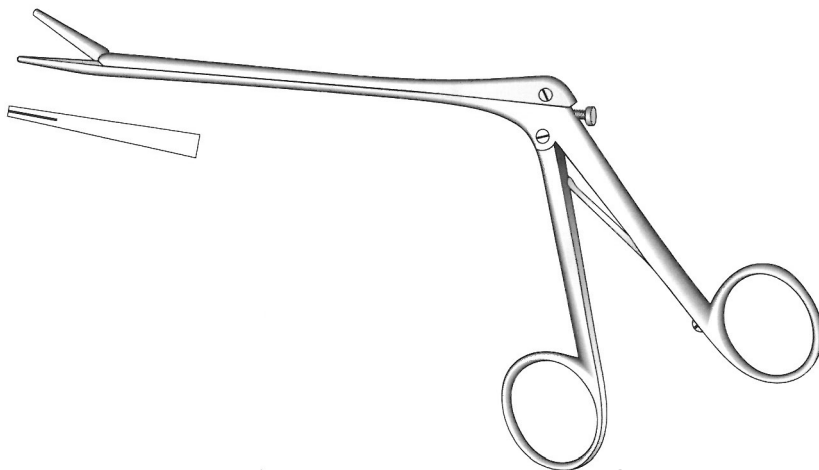

Olivecrona Toennis  
**MWH-25-160**  
 14 cm / 5½"

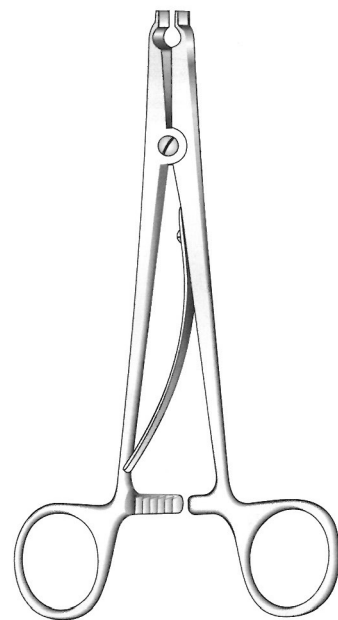

Raney  
**MWH-25-170**  
 16.5 cm / 6½"

# Neurosurgery

Nerve Root Retractors and Brain Spatula

Nervwurzelhaken und Hirnspatel

Separadores para la raiz de nervio y Espatulas Cerebrales

M.W.Hartmann

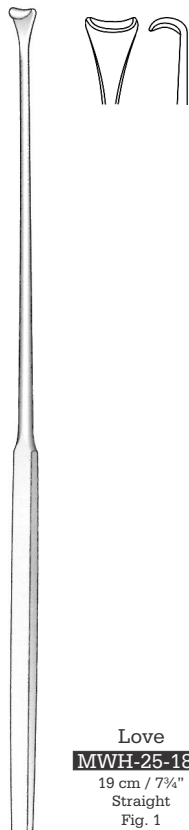

Love  
**MWH-25-180**  
19 cm / 7 3/4"  
Straight  
Fig. 1



Cushing  
**MWH-25-210** 17 cm / 6 3/4"  
**MWH-25-220** 20 cm / 8"  
**MWH-25-230** 28 cm / 11 1/4"

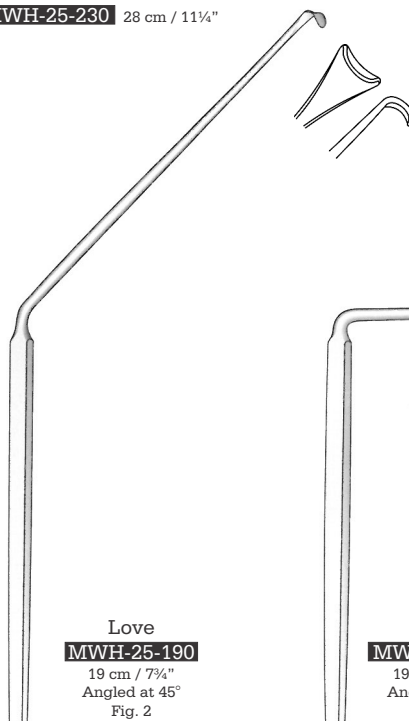

Love  
**MWH-25-190**  
19 cm / 7 3/4"  
Angled at 45°  
Fig. 2

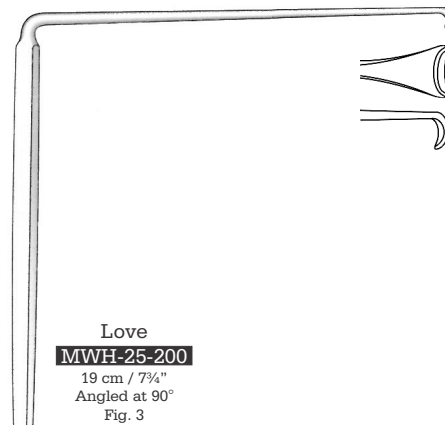

Love  
**MWH-25-200**  
19 cm / 7 3/4"  
Angled at 90°  
Fig. 3

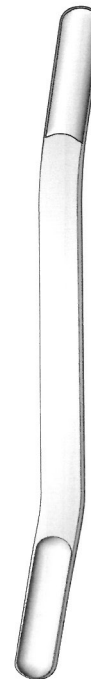

Olivecrona  
**MWH-25-240** 7 x 9 mm  
**MWH-25-250** 11 x 13 mm  
**MWH-25-260** 15 x 18 mm  
**MWH-25-270** 18 x 22 mm  
18 cm / 7"  
Concave

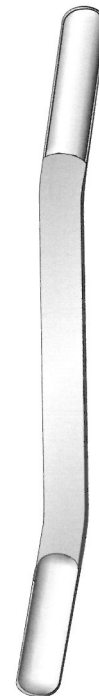

Olivecrona  
**MWH-25-280** 7 x 9 mm  
**MWH-25-290** 11 x 13 mm  
**MWH-25-300** 15 x 18 mm  
**MWH-25-310** 18 x 22 mm  
18 cm / 7"  
Convex

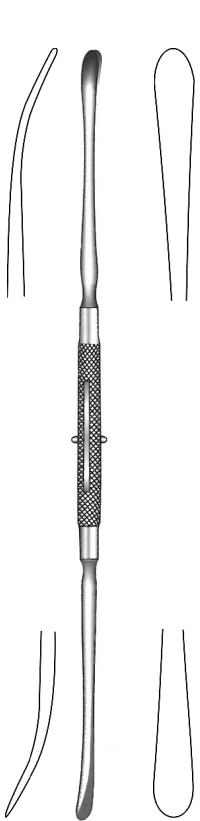

Davis  
MWH-25-181  
24.5 cm / 9 3/4"

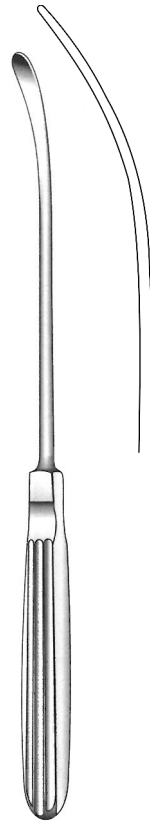

Sachs  
MWH-25-182  
21 cm / 8 1/4"

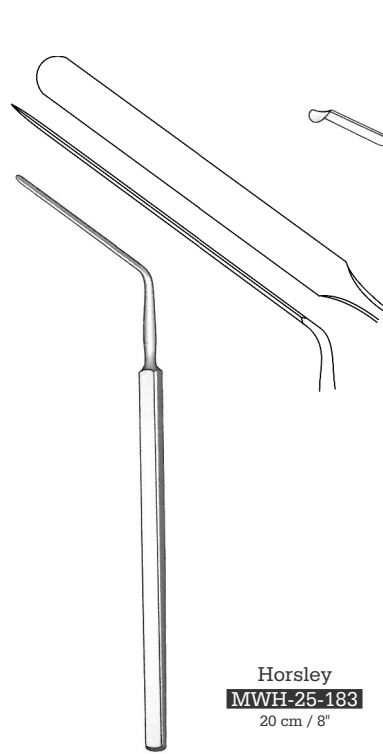

Horsley  
MWH-25-183  
20 cm / 8"

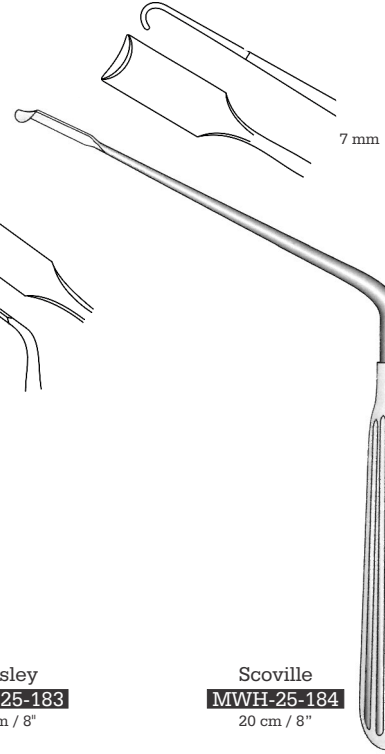

Scoville  
MWH-25-184  
20 cm / 8"

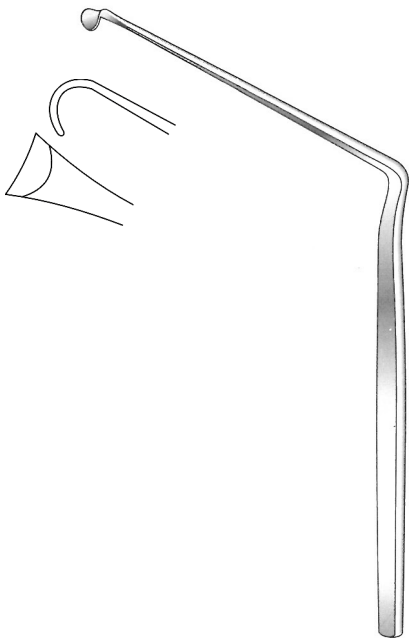

Surgicon  
MWH-25-185  
21 cm / 8 1/4"

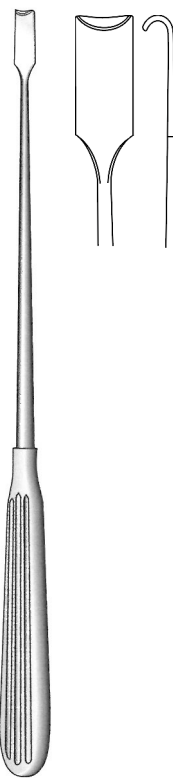

Scoville  
MWH-25-186  
23 cm / 9"

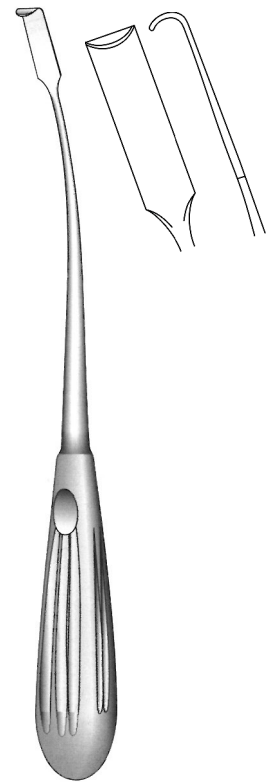

Holsher  
MWH-25-187  
24 cm / 9 1/2"

# Neurosurgery

Nerve Retractors

Nervwurzelnhaken

Separadores para la raiz de nervio

*M.W.Hartmann*

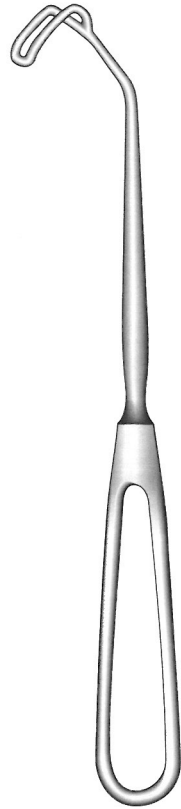

Cushing  
**MWH-25-188**  
21.5 cm / 8½"



Sachs  
**MWH-25-189**  
21.5 cm / 8½"



Sachs  
**MWH-25-191**  
21.5 cm / 8½"



Cushing  
**MWH-25-192**  
23 cm / 9"

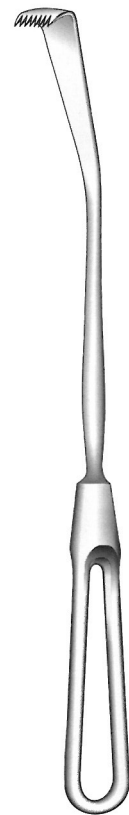

Sachs  
**MWH-25-193**  
21.5 cm / 8½"



Dandy  
**MWH-25-320**  
 20 cm / 8"

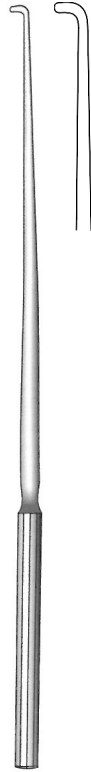

Dandy  
**MWH-25-330**  
 20 cm / 8"



Dandy  
**MWH-25-340**  
 20 cm / 8"



Cushing



Fig. 1  
**MWH-25-360** 19 cm / 7 3/4"  
**MWH-25-361** 28 cm / 11"



Fig. 2  
**MWH-25-370**  
**MWH-25-371**



Graham  
**MWH-25-390**  
 16.5 cm / 6 1/2"  
 Blunt



Sachs  
**MWH-25-400**  
 18.5 cm / 7 1/4"  
 Sharp



Cushing  
**MWH-25-410**  
 14 cm / 5 1/2"



Frazier  
**MWH-25-420** 13 cm / 5"  
**MWH-25-430** 18 cm / 7"  
 Sharp



**MWH-25-440**  
**MWH-25-450**  
 Blunt



Smithwick  
**MWH-25-460**  
 29 cm / 11 1/2"



Adson  
**MWH-25-910**  
 20 cm / 8"  
 Sharp blade 5 mm at right angle



# Neurosurgery

Dura Dissectors  
Dura-Dissektoren  
Disecacores para dura-madre

# M.W.Hartmann

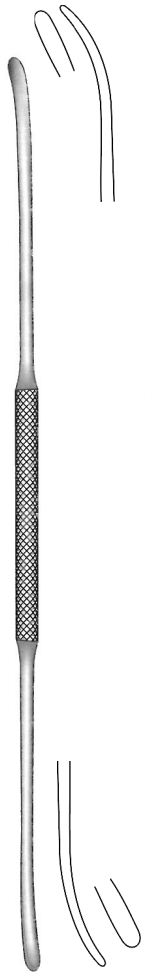

Olivecrona  
**MWH-25-391** 19.5 cm / 7¾"  
**MWH-25-392** 24 cm / 9½"

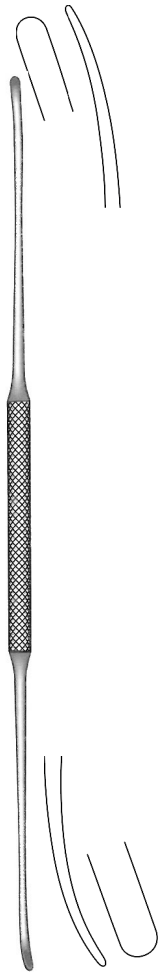

Olivecrona  
**MWH-25-393** 18 cm / 7"  
**MWH-25-394** 24 cm / 9½"

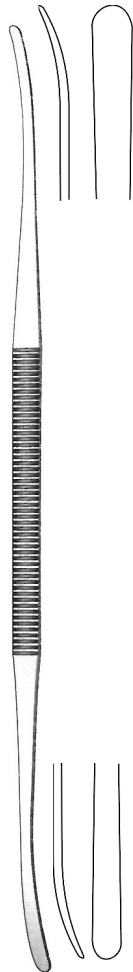

Toennis  
**MWH-25-395** 25 cm / 10"



Milligan  
**MWH-25-396** 21 cm / 8¼"

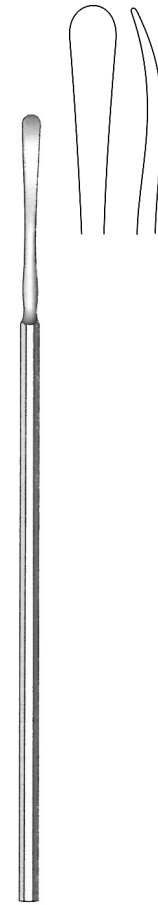

**MWH-25-397** 22 cm / 8¾"

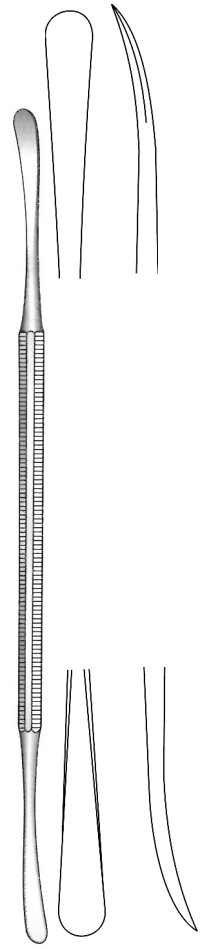

Sachs  
**MWH-25-398** 21 cm / 8¼"

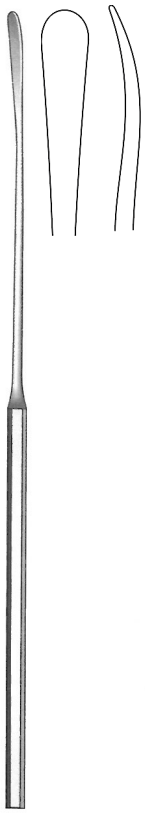

Sachs  
MWH-25-399  
21 cm / 8¼"

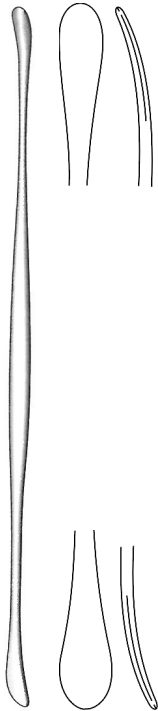

Penfield  
MWH-25-401  
29 cm / 11½"

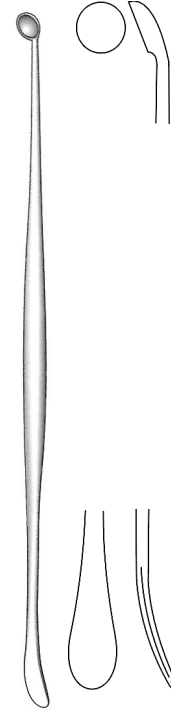

Penfield  
MWH-25-402  
17.5 cm / 7"

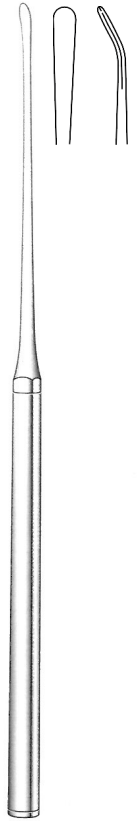

Penfield  
MWH-25-403  
21.5 cm / 8½"

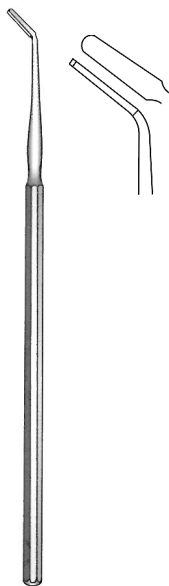

Hoen  
MWH-25-404  
15 cm / 6"

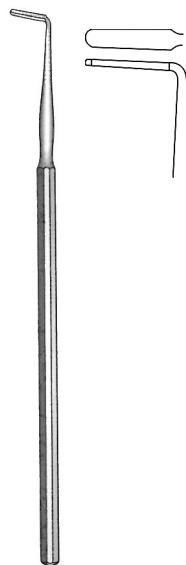

Hoen  
MWH-25-405  
15 cm / 6"

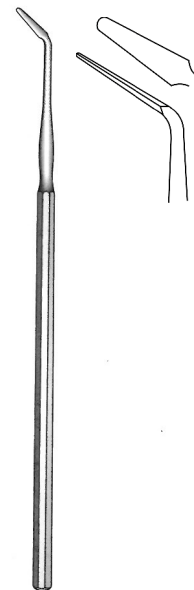

Frazier  
MWH-25-406  
15 cm / 6"

# NeuroSurgery

Exploring Cannula, Suction tubes and Tampons Cannula  
Punktionskanulen, Saugkanulen und Tamponrohre  
Canulas Ventriculares, Tubos de aspiracion y Canula P/tapones

*M.W.Hartmann*

For more suction tubes see page 22

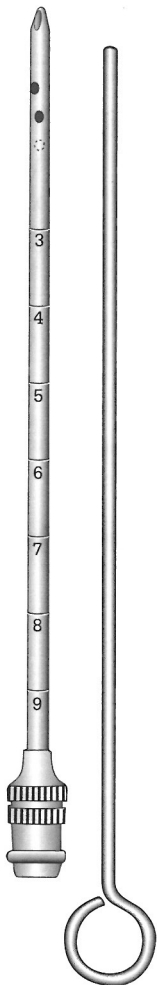

Frazier  
**MWH-25-470**  
3 mm  $\varnothing$   
Silver plated  
**MWH-25-475**  
2 mm  $\varnothing$   
Gold plated  
12 cm / 4 3/4"

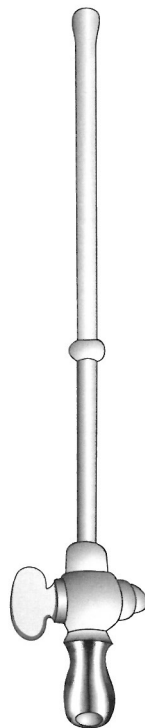

Seiffert  
**MWH-25-530**  
12.5 cm / 5"

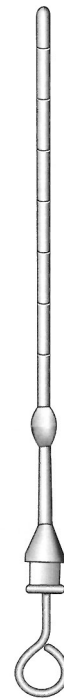

Elsberg  
**MWH-25-920**  
11 cm / 4 3/4"  
7 Fr. 2.3 mm, luer lock sterling,  
3 hole closed end



Inge  
MWH-25-532  
24 cm / 9½"

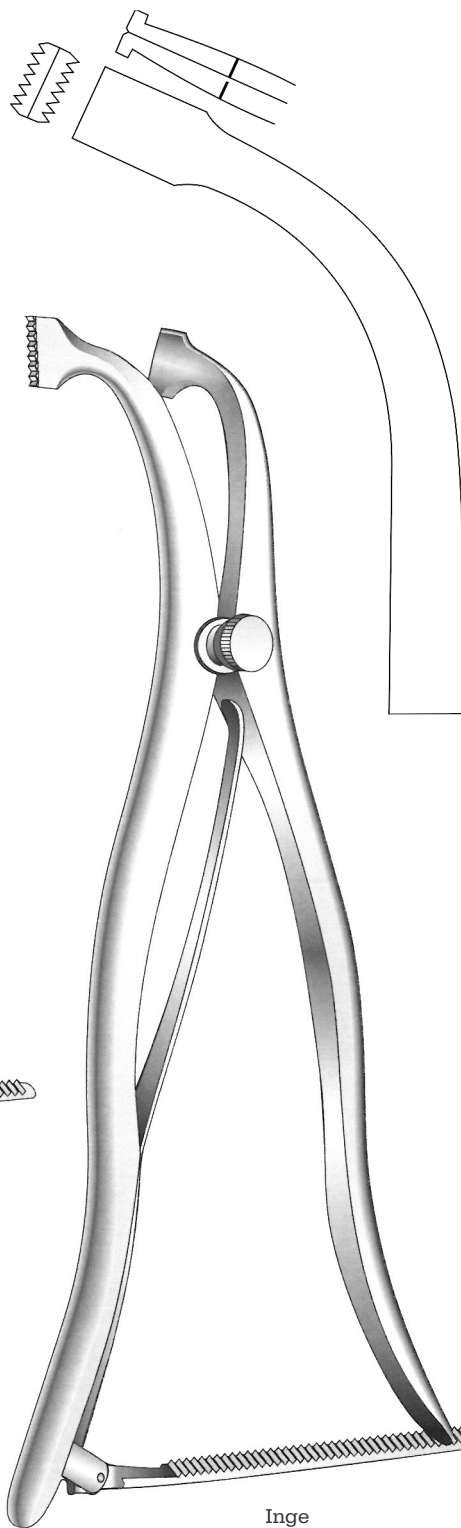

Inge  
MWH-25-533  
24 cm / 9½"

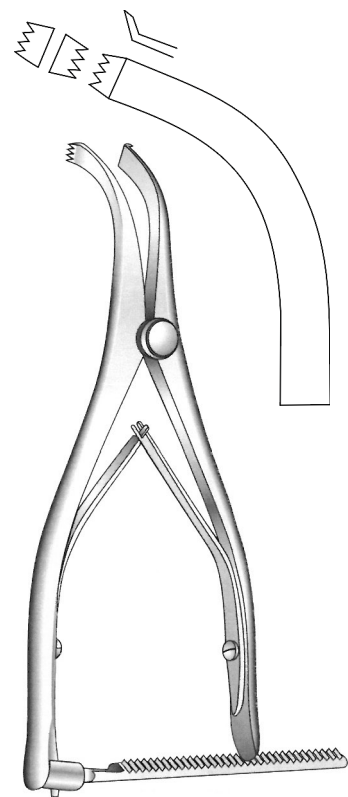

Inge  
MWH-25-531  
16 cm / 6¼"

# NeuroSurgery

Lamina Spreaders, Wound Spreaders

Wirbelkörperspreizer, Wundspreizer

Separadores para cuerpos vertebrales, Separadores autoostaticos

*M.W.Hartmann*

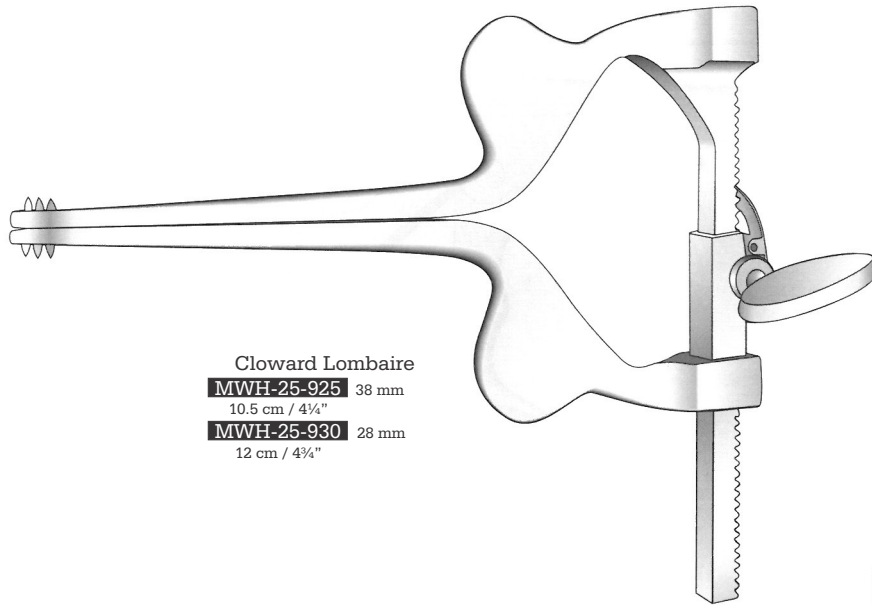

Cloward Lombaire  
**MWH-25-925** 38 mm  
10.5 cm / 4¼"  
**MWH-25-930** 28 mm  
12 cm / 4¾"

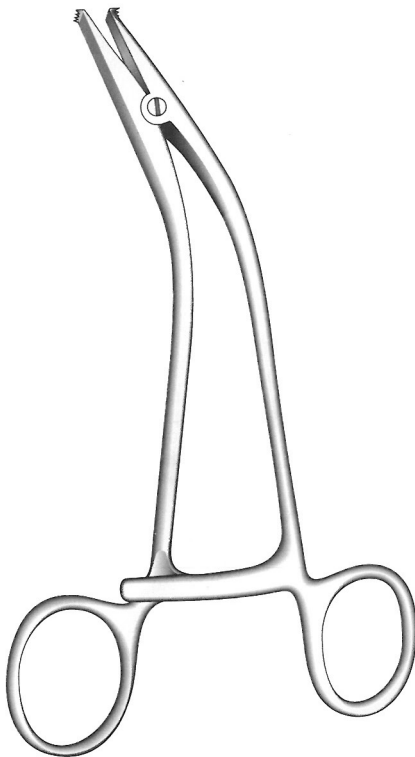

Cloward  
**MWH-25-940** 16 cm / 6¼"  
**MWH-25-945** 20 cm / 8"

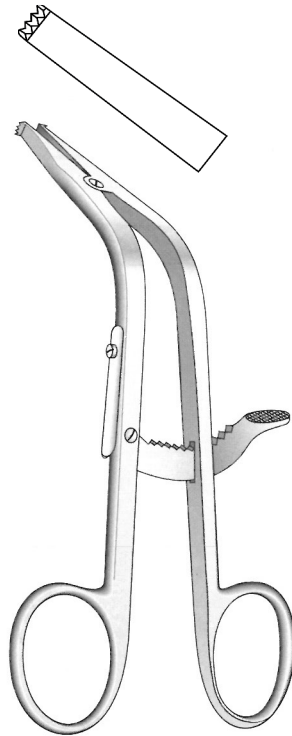

Cloward  
**MWH-25-535**  
16 cm / 6¼"

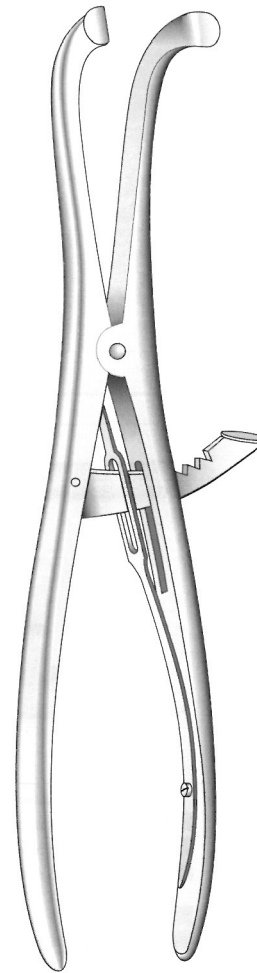

Mathey  
**MWH-25-800**  
18 cm / 7"

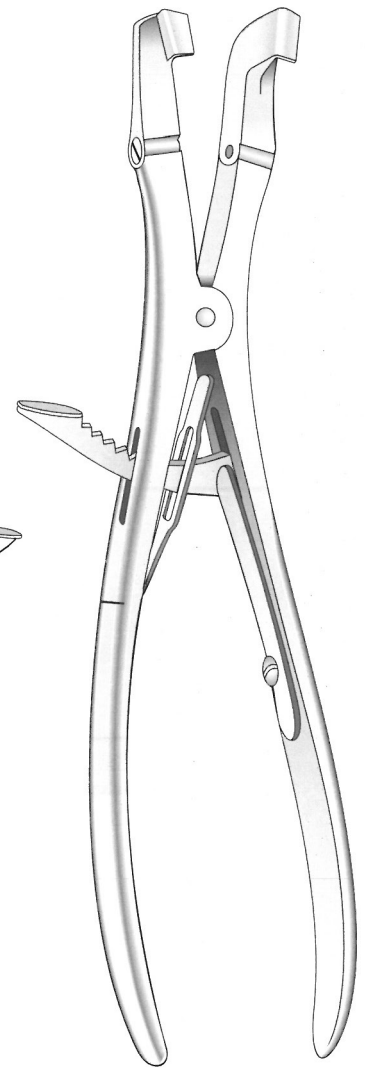

Maurer  
**MWH-25-805**  
20 cm / 8"

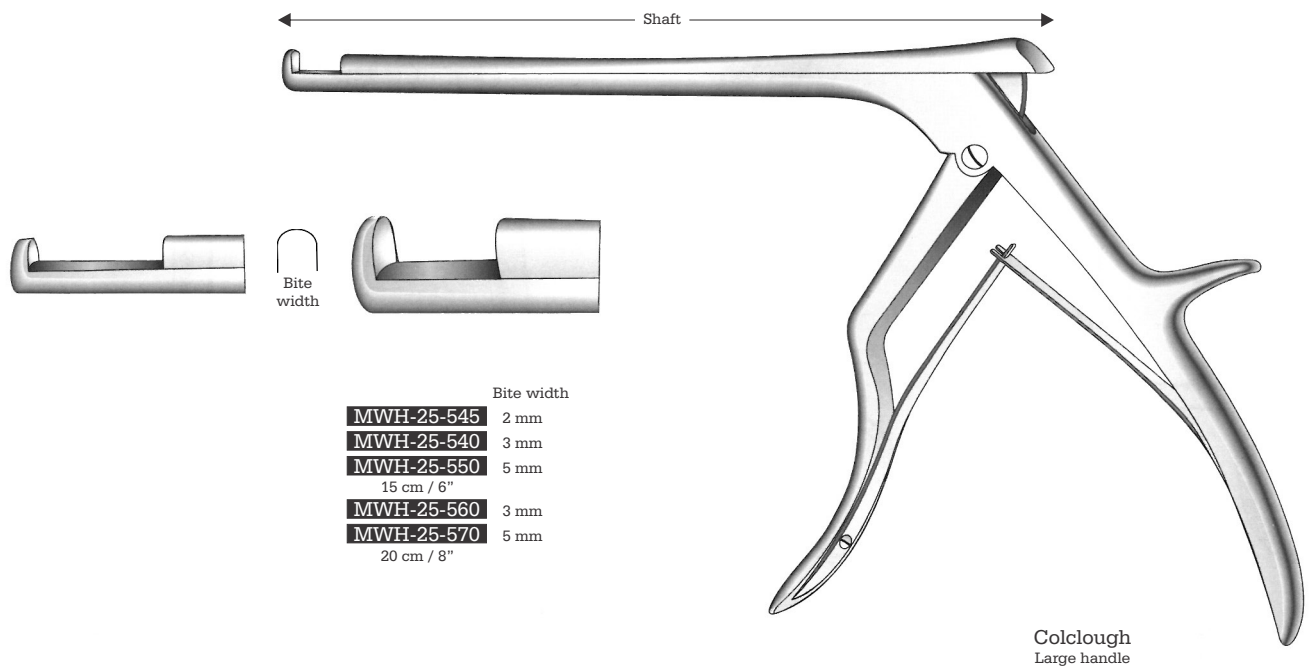
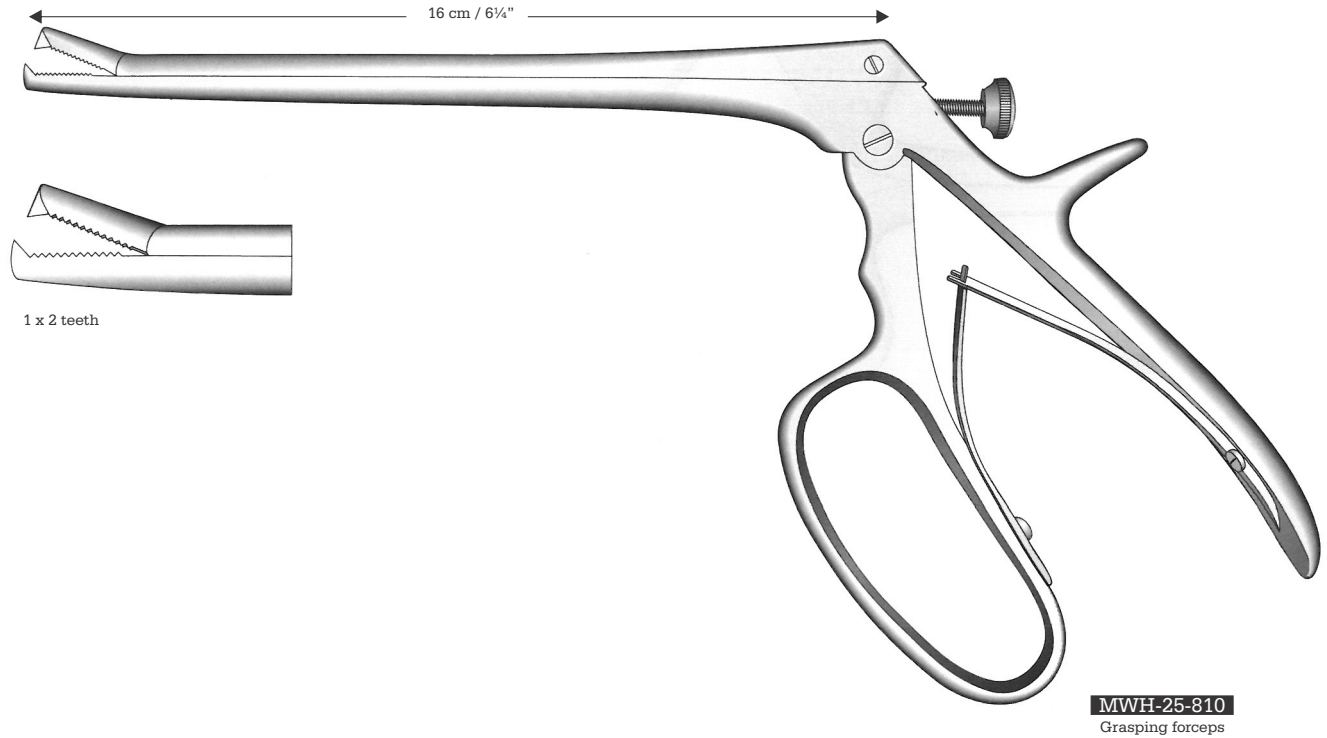

# NeuroSurgery

Intervertebral Disc Rongeurs

Bandscheibenstanzen

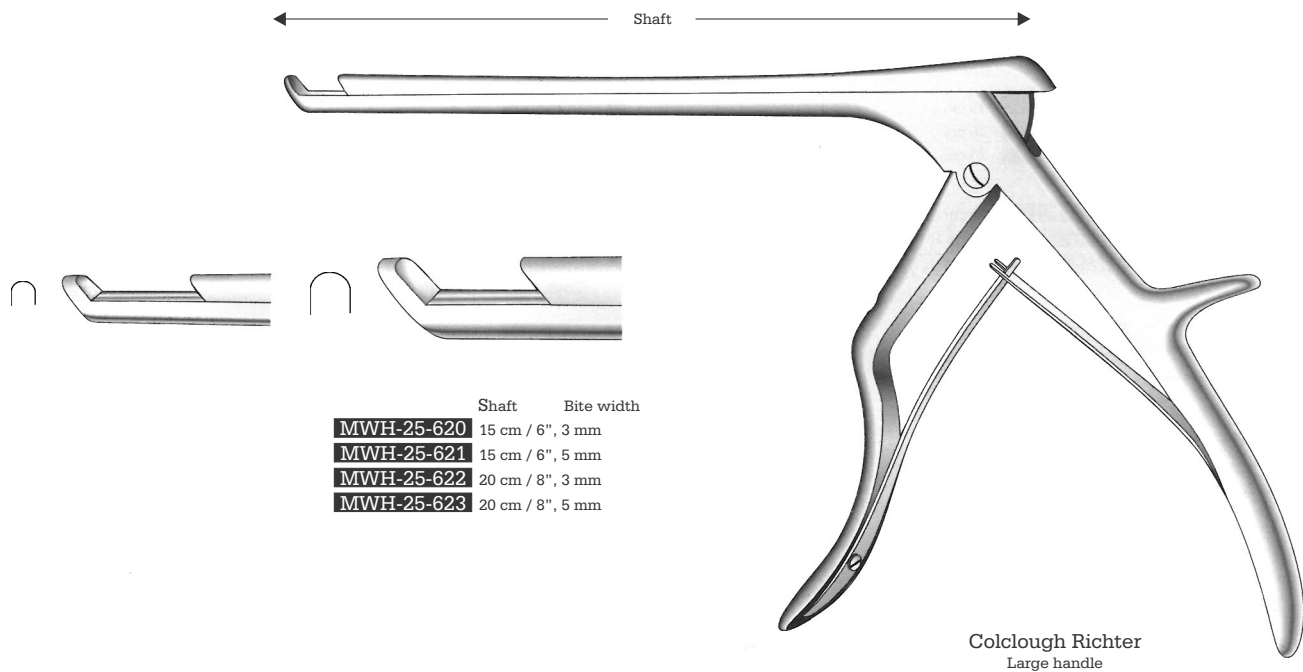
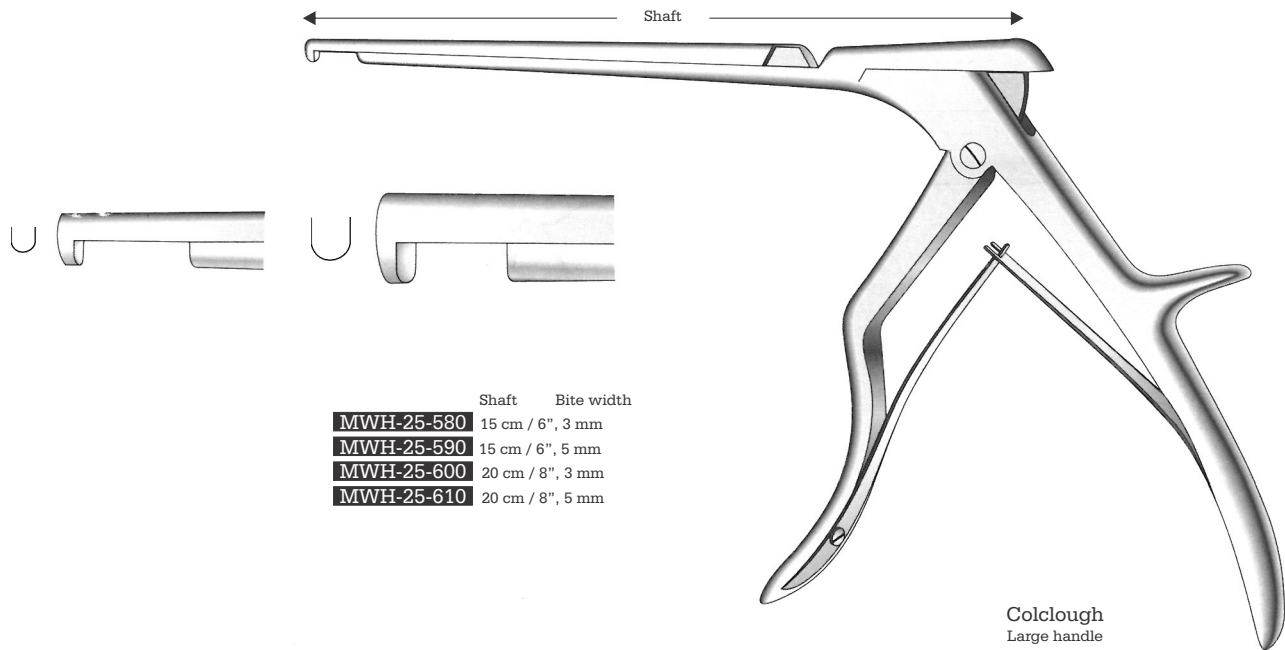

Pinzas cortantes para discos intervertebrales

# M.W.Hartmann

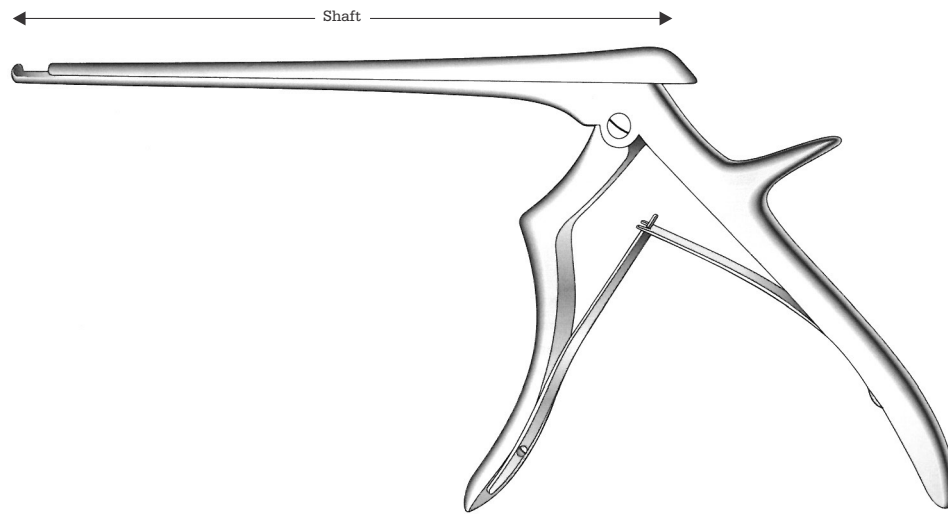

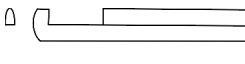
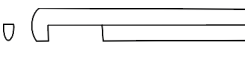
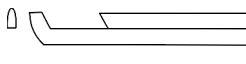
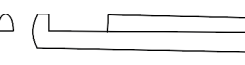
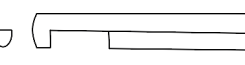
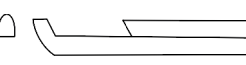
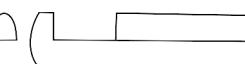
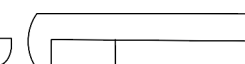
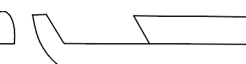
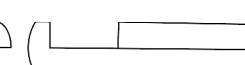
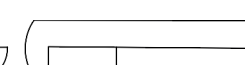
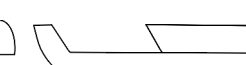
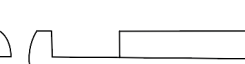
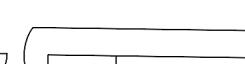
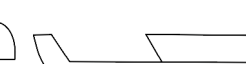

Ferris-Smith-Kerrison

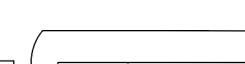
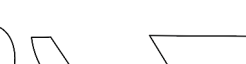
Upward cutting	Downward cutting	Forward cutting
 <b>MWH-25-1100</b> 15 cm <b>MWH-25-1101</b> 18 cm <b>MWH-25-1102</b> 20 cm 1 mm	 <b>MWH-25-1130</b> 15 cm <b>MWH-25-1131</b> 18 cm <b>MWH-25-1132</b> 20 cm 1 mm	 <b>MWH-25-1160</b> 15 cm <b>MWH-25-1161</b> 18 cm <b>MWH-25-1162</b> 20 cm 1 mm
 <b>MWH-25-1105</b> 15 cm <b>MWH-25-1106</b> 18 cm <b>MWH-25-1107</b> 20 cm 2 mm	 <b>MWH-25-1135</b> 15 cm <b>MWH-25-1136</b> 18 cm <b>MWH-25-1137</b> 20 cm 2 mm	 <b>MWH-25-1165</b> 15 cm <b>MWH-25-1166</b> 18 cm <b>MWH-25-1167</b> 20 cm 2 mm
 <b>MWH-25-1110</b> 15 cm <b>MWH-25-1111</b> 18 cm <b>MWH-25-1112</b> 20 cm 3 mm	 <b>MWH-25-1140</b> 15 cm <b>MWH-25-1141</b> 18 cm <b>MWH-25-1142</b> 20 cm 3 mm	 <b>MWH-25-1170</b> 15 cm <b>MWH-25-1171</b> 18 cm <b>MWH-25-1172</b> 20 cm 3 mm
 <b>MWH-25-1115</b> 15 cm <b>MWH-25-1116</b> 18 cm <b>MWH-25-1117</b> 20 cm 4 mm	 <b>MWH-25-1145</b> 15 cm <b>MWH-25-1146</b> 18 cm <b>MWH-25-1147</b> 20 cm 4 mm	 <b>MWH-25-1175</b> 15 cm <b>MWH-25-1176</b> 18 cm <b>MWH-25-1177</b> 20 cm 4 mm
 <b>MWH-25-1120</b> 15 cm <b>MWH-25-1121</b> 18 cm <b>MWH-25-1122</b> 20 cm 5 mm	 <b>MWH-25-1150</b> 15 cm <b>MWH-25-1151</b> 18 cm <b>MWH-25-1152</b> 20 cm 5 mm	 <b>MWH-25-1180</b> 15 cm <b>MWH-25-1181</b> 18 cm <b>MWH-25-1182</b> 20 cm 5 mm
 <b>MWH-25-1125</b> 15 cm <b>MWH-25-1126</b> 18 cm <b>MWH-25-1127</b> 20 cm 6 mm	 <b>MWH-25-1155</b> 15 cm <b>MWH-25-1156</b> 18 cm <b>MWH-25-1157</b> 20 cm 6 mm	 <b>MWH-25-1185</b> 15 cm <b>MWH-25-1186</b> 18 cm <b>MWH-25-1187</b> 20 cm 6 mm



# Neurosurgery

Intervertebral Disc Rongeurs

Bandscheibenstanzen

Pinzas cortantes para discos intervertebrales

M.W.Hartmann

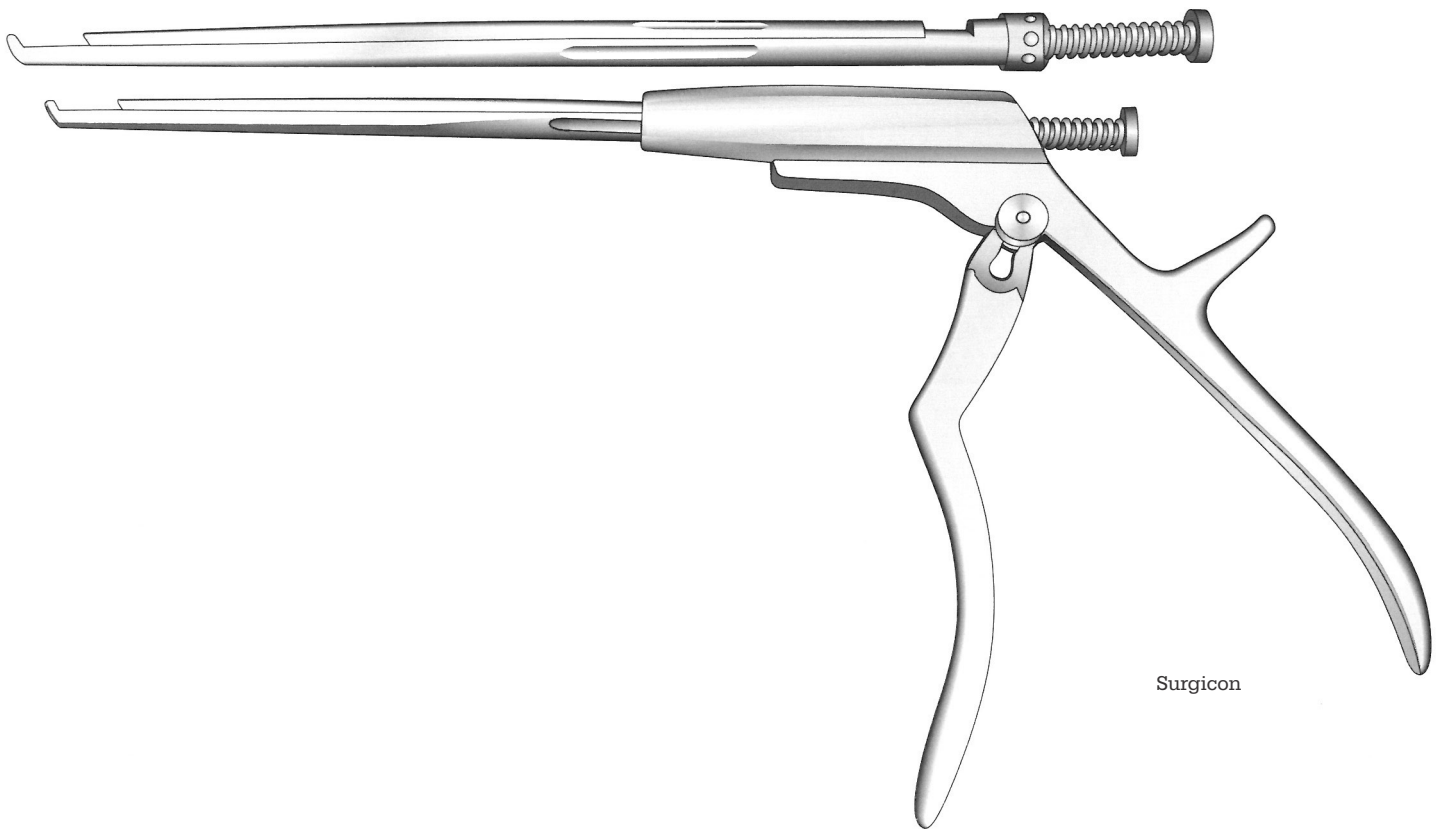

Surigicon

Upward cutting

	MWH-25-1200	15 cm
	MWH-25-1201	18 cm
	MWH-25-1202	20 cm
1 mm		
	MWH-25-1205	15 cm
	MWH-25-1206	18 cm
	MWH-25-1207	20 cm
2 mm		
	MWH-25-1210	15 cm
	MWH-25-1211	18 cm
	MWH-25-1212	20 cm
3 mm		
	MWH-25-1215	15 cm
	MWH-25-1216	18 cm
	MWH-25-1217	20 cm
4 mm		
	MWH-25-1220	15 cm
	MWH-25-1221	18 cm
	MWH-25-1222	20 cm
5 mm		
	MWH-25-1225	15 cm
	MWH-25-1226	18 cm
	MWH-25-1227	20 cm
6 mm		

Forward cutting

	MWH-25-1230	15 cm
	MWH-25-1231	18 cm
	MWH-25-1232	20 cm
1 mm		
	MWH-25-1235	15 cm
	MWH-25-1236	18 cm
	MWH-25-1237	20 cm
2 mm		
	MWH-25-1240	15 cm
	MWH-25-1241	18 cm
	MWH-25-1242	20 cm
3 mm		
	MWH-25-1245	15 cm
	MWH-25-1246	18 cm
	MWH-25-1247	20 cm
4 mm		
	MWH-25-1250	15 cm
	MWH-25-1251	18 cm
	MWH-25-1252	20 cm
5 mm		
	MWH-25-1255	15 cm
	MWH-25-1256	18 cm
	MWH-25-1257	20 cm
6 mm		

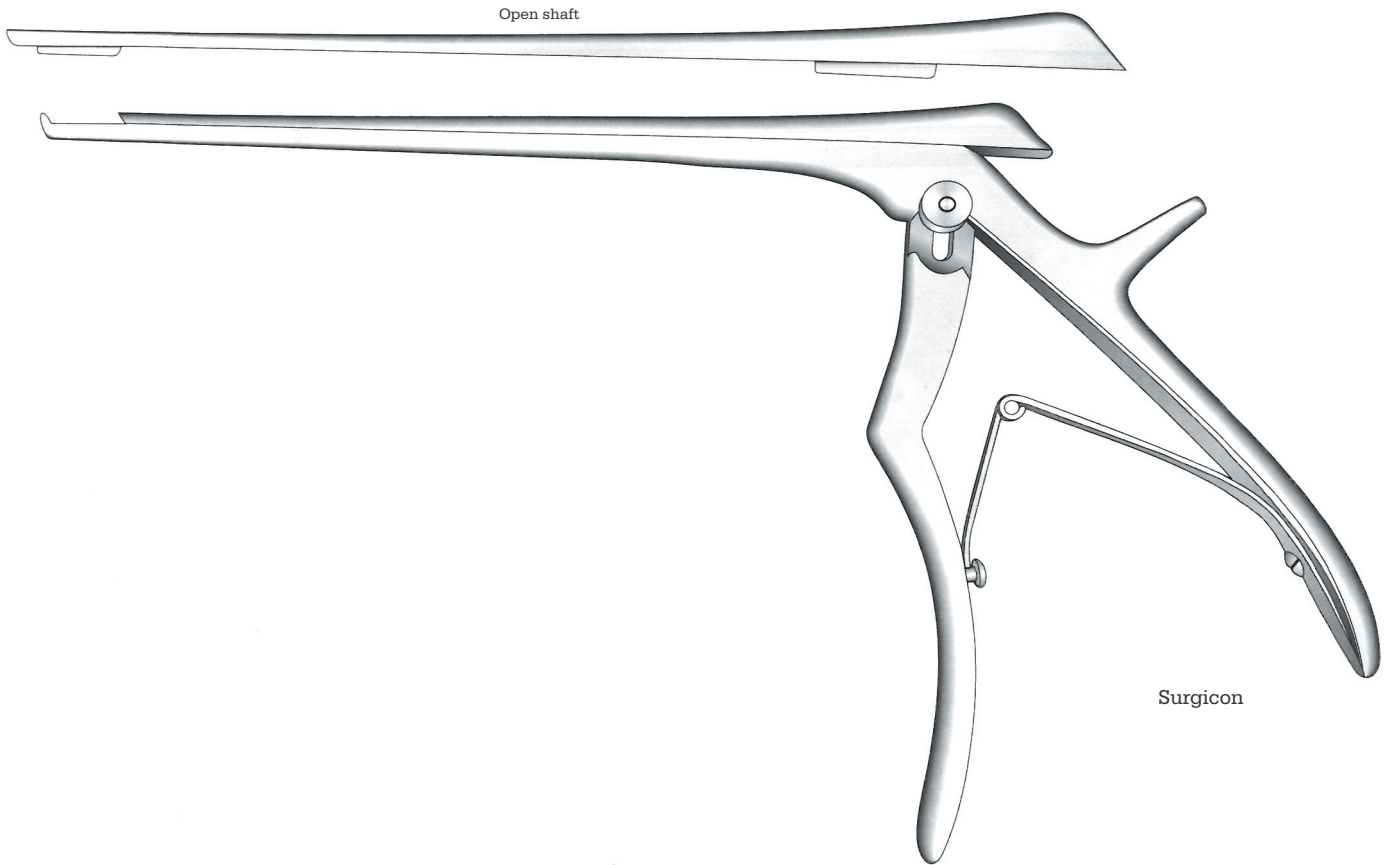

Upward cutting		Downward cutting		Forward cutting	
	MWH-25-1300 15 cm MWH-25-1301 18 cm MWH-25-1302 20 cm 1 mm		MWH-25-1330 15 cm MWH-25-1331 18 cm MWH-25-1332 20 cm 1 mm		MWH-25-1360 15 cm MWH-25-1361 18 cm MWH-25-1362 20 cm 1 mm
	MWH-25-1305 15 cm MWH-25-1306 18 cm MWH-25-1307 20 cm 2 mm		MWH-25-1335 15 cm MWH-25-1336 18 cm MWH-25-1337 20 cm 2 mm		MWH-25-1365 15 cm MWH-25-1366 18 cm MWH-25-1367 20 cm 2 mm
	MWH-25-1310 15 cm MWH-25-1311 18 cm MWH-25-1312 20 cm 3 mm		MWH-25-1340 15 cm MWH-25-1341 18 cm MWH-25-1342 20 cm 3 mm		MWH-25-1370 15 cm MWH-25-1371 18 cm MWH-25-1372 20 cm 3 mm
	MWH-25-1315 15 cm MWH-25-1316 18 cm MWH-25-1317 20 cm 4 mm		MWH-25-1345 15 cm MWH-25-1346 18 cm MWH-25-1347 20 cm 4 mm		MWH-25-1375 15 cm MWH-25-1376 18 cm MWH-25-1377 20 cm 4 mm
	MWH-25-1320 15 cm MWH-25-1321 18 cm MWH-25-1322 20 cm 5 mm		MWH-25-1350 15 cm MWH-25-1351 18 cm MWH-25-1352 20 cm 5 mm		MWH-25-1380 15 cm MWH-25-1381 18 cm MWH-25-1382 20 cm 5 mm
	MWH-25-1325 15 cm MWH-25-1326 18 cm MWH-25-1327 20 cm 6 mm		MWH-25-1355 15 cm MWH-25-1356 18 cm MWH-25-1357 20 cm 6 mm		MWH-25-1385 15 cm MWH-25-1386 18 cm MWH-25-1387 20 cm 6 mm

# Neurosurgery

Laminectomy Rongeurs

Laminektomie-Zangen

Pinzas cortantes para laminectomia

M.W.Hartmann

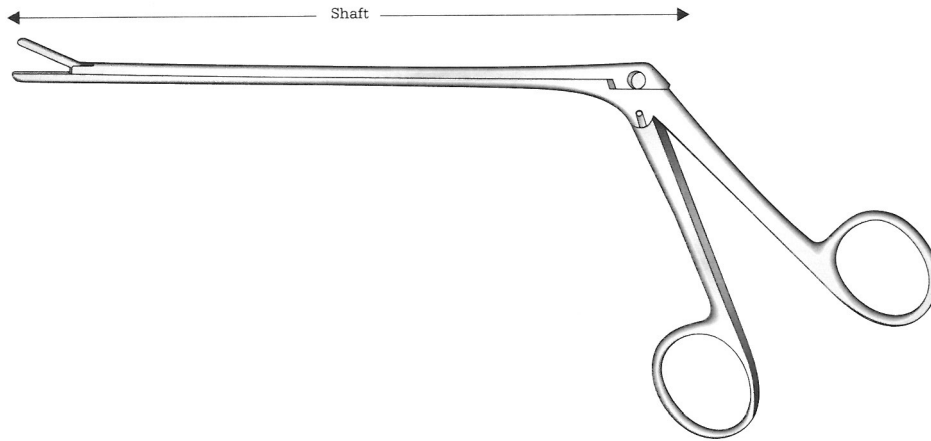

4 mm

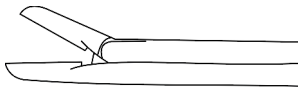

Spurling

**MWH-25-680** 12 cm

**MWH-25-681** 15 cm

**MWH-25-682** 18 cm

4 x 10 mm  
Straight

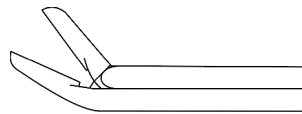

Spurling

**MWH-25-683** 12 cm

**MWH-25-684** 15 cm

**MWH-25-685** 18 cm

4 x 10 mm  
Angled at 45°  
Upward

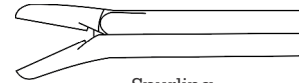

Spurling

**MWH-25-686** 12 cm

**MWH-25-687** 15 cm

**MWH-25-688** 18 cm

4 x 10 mm  
Angled at 45°  
Downward

3 mm

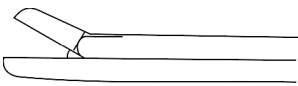

Love Gruenwald

**MWH-25-689** 12 cm

**MWH-25-690** 15 cm

**MWH-25-691** 18 cm

3 x 10 mm  
Straight

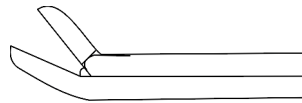

Love Gruenwald

**MWH-25-692** 12 cm

**MWH-25-693** 15 cm

**MWH-25-694** 18 cm

3 x 10 mm  
Angled at 45°  
Upward

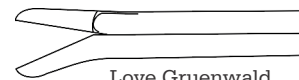

Love Gruenwald

**MWH-25-695** 12 cm

**MWH-25-696** 15 cm

**MWH-25-697** 18 cm

3 x 10 mm  
Angled at 45°  
Downward

2 mm

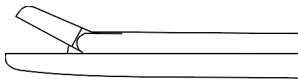

Cushing

**MWH-25-698** 12 cm

**MWH-25-699** 15 cm

**MWH-25-700** 18 cm

2 x 10 mm  
Straight

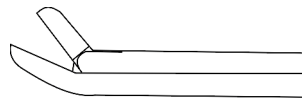

Cushing

**MWH-25-701** 12 cm

**MWH-25-702** 15 cm

**MWH-25-703** 18 cm

2 x 10 mm  
Angled at 45°  
Upward

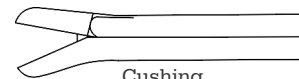

Cushing

**MWH-25-704** 12 cm

**MWH-25-705** 15 cm

**MWH-25-706** 18 cm

2 x 10 mm  
Angled at 45°  
Downward

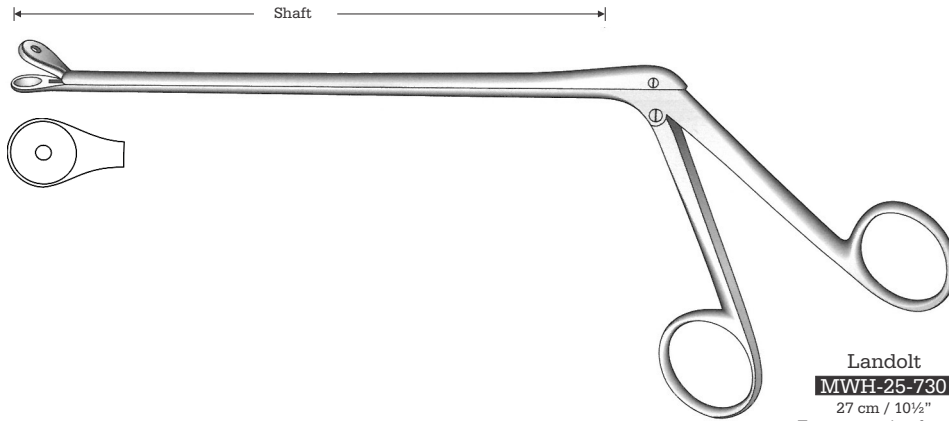

Landolt  
**MWH-25-730**  
27 cm / 10½"  
Tumor grasping forceps  
Length of shaft: 20 cm / 8", blunt

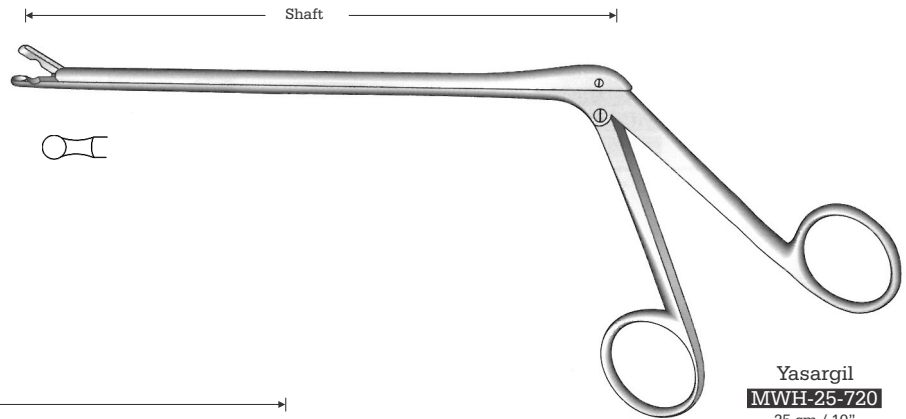

Yasargil  
**MWH-25-720**  
25 cm / 10"  
Pituitary rongeur  
Length of shaft: 18 cm / 7", sharp

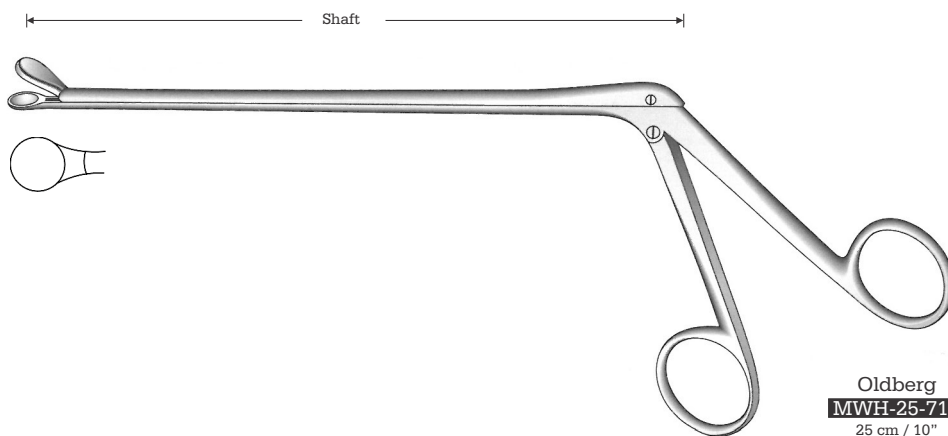

Oldberg  
**MWH-25-710**  
25 cm / 10"  
Length of shaft: 18 cm / 7"